

Harmonia MR16 12V LED Downlights

Cat. No. FLDL703KMR16, FLDL704KMR16,
FLDL903KMR16, FLDL904KMR16

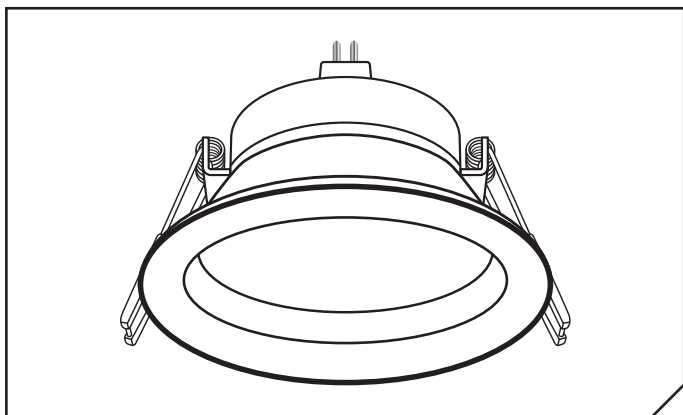

LUMINAIRE DESIGNERS, MANUFACTURERS & SUPPLIERS



Important

- For this product to work, it must be connected to a 12V a.c. transformer via an MR16 low voltage lead.
- This product works with most leading 12V a.c. transformers. Compatibility with transformer must be checked prior to usage.
- The input power specified below is typical. Actual input power will vary depending on the transformer.
- This product is not dimmable. It will be damaged if connected to a dimmer.
- This product is meant for aftermarket replacement of incandescent/halogen MR16 downlight heads.

Installation

- Remove the existing MR16 12V downlight head from the ceiling cut-out.
- Disconnect the downlight head from the MR16 12V connector.
- Connect the new LED MR16 12V downlight head to the MR16 12V connector.
- Fold back the spring clips and insert the downlight head into the ceiling cut-out.

Maintenance

- This product should only be cleaned with a damp cloth. Cleaning agents and solvents should not be used.





Specifications

Cat No	FLDL703KMR16	FLDL704KMR16	FLDL903KMR16	FLDL904KMR16
Supply voltage	12V a.c. 50Hz			
Input power	7W		9W	
Lumens output	550lm	590lm	710lm	770lm
Colour temperature (Nominal)	3000K	4000K	3000K	4000K
Colour Rendering Index (CRI)	80+			
Beam angle	85°		95°	
Dimmable	No			
IP rating	IP44			
Insulation Rating	CA90		IC	
Ceiling cut-out size	Ø70mm		Ø90mm	
Depth into ceiling	75mm			
Fascia size	Ø93mm		Ø110mm	

Disclaimers

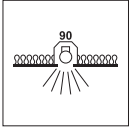

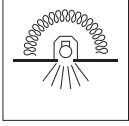
1. This product must be installed and used as per these instructions.
2. An IP rating of IP44 is generally considered suitable for external walls with supplementary protection such as overhanging eaves.
3. The IP rating of this product is only valid when installed on a flat and non-porous surface. Additional sealing may be required for irregular surfaces.
4. This product contains no serviceable parts and no attempt should be made to repair this product. If the product is faulty it should be discarded.
5. This product is not suitable for installation in hazardous and/or corrosive areas.
6. Electrical installations periodically receive transient over voltages. This product has been designed to minimise the effect of such voltages on connected equipment. It may not give full protection for extreme over-voltage transients such as those resulting from a close lighting strike.
7. This product utilises intellectual property in the form of registered designs, trademarks, and/or patents. Such intellectual property remains the property of FAMCO in all cases.
8. This product has been designed to operate in ambient temperatures: -10°C to 40°C.
9. Extended exposure to UV rays (such as exposure to direct sunlight) may cause discolouration of this product.
10. The material in this product may vary in colour from batch to batch. Colour matching from one batch to another cannot be guaranteed.
11. FAMCO reserves the right to modify the specification of this product at any time.

LED downlight head life

Cat No.	Average lifespan	Installation condition		
FLDL703KMR16	35,000h	Rated average LED lamp life at 25°C when installed with the default insulation clearances specified by AS/NZS 3000:2007		
FLDL704KMR16				
FLDL903KMR16				
FLDL904KMR16				
FLDL703KMR16	30,000h	Rated average LED lamp life at 25°C when installed with the thermal insulation abutting the fixture in accordance with the CA90 rating specified in AS/NZS 60598.2.2		
FLDL704KMR16				
FLDL903KMR16	30,000h	Rated average LED lamp life at 25°C when installed with the thermal insulation abutting and covering the fixture in accordance with the IC rating specified in AS/NZS 60598.2.2		
FLDL904KMR16				

Note: This form of installation complies with the Wiring Rules AS/NZS 3000:2007 requirement for recessed downlights, clause 4.5.2.3.1 (i).

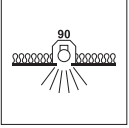
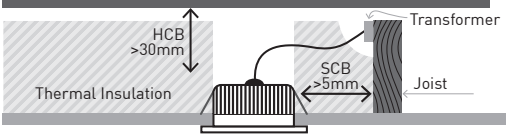
LED downlight head insulation rating

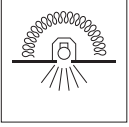
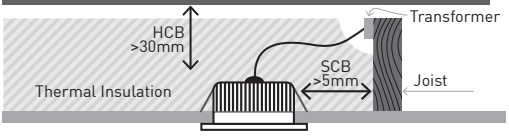
Cat No.	Installation Rating			
FLDL703KMR16	<p>These downlight heads have achieved a CA90 insulation rating in accordance with AS/NZS 60598.2.2. A type CA90 luminaire can be installed with building insulation material that can safely be exposed continuously to temperatures up to 90°C. Such insulation must not cover but may closely abut the side of the luminaire. Refer to the diagram shown for clarification.</p>			
FLDL704KMR16				
FLDL903KMR16	<p>These downlight heads have achieved an IC insulation rating in accordance with AS/NZS 60598.2.2. A type IC luminaire can be installed with building insulation material that can safely be exposed continuously to temperatures up to 90°C. Such insulation can cover and abut the side of the luminaire. Refer to the diagram shown for clarification.</p>			
FLDL904KMR16				

Note: Not suitable for use with loose-fill insulation. If installed in accordance with IC/CA90 rating, insulation must have a temperature rating exceeding 90°C.

This insulation rating is applicable to the FLDL LED Downlight head only. It is recommended that transformers be placed above the insulation or as per the manufacturer's instructions.

RISK OF FIRE – Required clearance from structural members and building elements SCB = 5mm HCB = 30mm

SCB – Side Clearance to Building element: Minimum distance between the side of the recessed luminaire and any building element.

HCB – Height Clearance to Building element: Minimum distance between the top of the recessed luminaire and any building element above it.

Warranty

FAMCO warrants this product for a period of 3 years from the date of purchase. These goods come with guarantees that cannot be excluded under the Australian and New Zealand Consumer Laws. You are entitled to a replacement or a refund for a major failure and for compensation for any other reasonably foreseeable loss or damage. You are also entitled to have the goods repaired if the goods fail to be of acceptable quality and the failure does not amount to a major failure. Consult Famco Lighting Pty Ltd Conditions of Sale for details on warranty liability. If this lighting unit is faulty, return the unit freight pre-paid to your point of purchase, or contact Famco Lighting Pty Ltd on +61 (03) 9935 7300.

Customer Service

For all Customer Service and Technical Support enquires please call Monday to Friday during business hours.

Famco Lighting PTY LTD
+61 (03) 9935 7300
www.famco.com.au

ABN: 22 091 160 440